

# OSRAM OSTAR Observation (850nm)

## Lead (Pb) Free Product - RoHS Compliant

### SFH 4730, SFH 4740

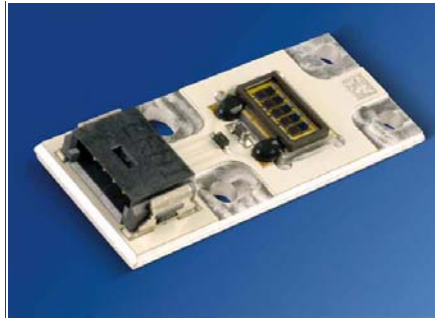

SFH 4730

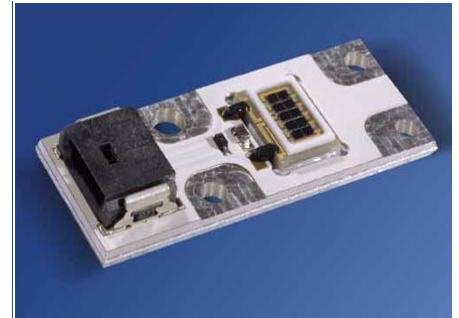

SFH 4740

#### SFH 4730

- Schwarzer Rahmen zur Streulichtminimierung
- 3.6 W optische Leistung bei IF=1A

#### SFH 4740

- Weißer Rahmen für hohe Lichtleistung
- 4.3 W optische Leistung bei IF=1A

#### Wesentliche Merkmale

- Aktive Chipfläche 2.1 x 5.4 mm<sup>2</sup>
- max. Gleichstrom 1 A
- niedriger Wärmewiderstand (2.8 K/W)
- Emissionswellenlänge 850 nm
- ESD-sicher bis 2 kV nach JESD22-A114-E
- Augensicherheitsrichtlinien der IEC-Normen 60825-1 und 62471 müssen beachtet werden.

#### Anwendungen

- Infrarotbeleuchtung für Kameras
- Überwachungssysteme
- IR-Datenübertragung
- Fahrer-Assistenz Systeme

#### SFH 4730

- Black frame to minimize scattered light
- 3.6 W optical power at IF=1A

#### SFH 4740

- White frame to achieve high optical power
- 4.3 W optical power at IF=1A

#### Features

- Active chip area 2.1 x 5.4 mm<sup>2</sup>
- max. DC-current 1 A
- Low thermal resistance (2.8 K/W)
- Spectral emission at 850 nm
- ESD safe up to 2 kV acc. to JESD22-A114-E
- Eye safety precautions given in IEC 60825-1 and IEC 62471 have to be followed.

#### Applications

- Infrared Illumination for cameras
- Surveillance systems
- IR Data Transmission
- Driver assistance systems

Typ Type	Bestellnummer Ordering Code	Strahlstärke <sup>1)</sup> ( $I_F = 1A, t_p = 20 \text{ ms}$ ) Radiant intensity <sup>1)</sup> $I_e$ (mW/sr)
SFH 4730	Q65110A5452	≥ 800 (typ.1200)
SFH 4740	Q65110A6190	≥ 1000 (typ.1400)

<sup>1)</sup> gemessen bei einem Raumwinkel  $\Omega = 0.01 \text{ sr}$  / measured at a solid angle of  $\Omega = 0.01 \text{ sr}$ .

**Grenzwerte**  
**Maximum Ratings**

Bezeichnung Parameter	Symbol Symbol	Wert Value	Einheit Unit
Betriebs- und Lagertemperatur Operating and storage temperature range	$T_{B, op}, T_{B, stg}$	- 40 ... + 125	°C
Sperrschichttemperatur Junction temperature	$T_J$	+ 145	°C
Sperrspannung Reverse voltage	$V_R$	0.5	V
Vorwärtsgleichstrom, $T_B^{1)} \leq 90$ °C Forward current	$I_F$	1	A
Stoßstrom, $t_p < 3$ ms, $D = 0$ Surge current	$I_{FSM}$	5	A
Leistungsaufnahme, $T_B \leq 90$ °C Power consumption	$P_{tot}$	19	W
Thermische Verlustleistung, $T_B \leq 90$ °C Thermal power-dissipation	$P_{th}$	15.4	W
Wärmewiderstand Sperrschicht / Bodenplatte Thermal resistance Junction / Base plate	$R_{thJB}$	2.8	K/W

<sup>1)</sup>  $T_B$  = Temperatur auf der Rückseite der Metallkernplatine / Temperature at the backside of the base plate.

Kennwerte ( $T_B = 25\text{ °C}$ )

## Characteristics

Bezeichnung Parameter	Symbol Symbol	Wert Value	Einheit Unit
Wellenlänge der Strahlung Wavelength at peak emission $I_F = 1\text{ A}$ , $t_p = 10\text{ ms}$	$\lambda_{\text{peak}}$	860	nm
Schwerpunkts-Wellenlänge der Strahlung Centroid wavelength $I_F = 1\text{ A}$ , $t_p = 10\text{ ms}$	$\lambda_{\text{centroid}}$	850	nm
Spektrale Bandbreite bei 50% von $I_{\text{max}}$ Spectral bandwidth at 50% of $I_{\text{max}}$ $I_F = 1\text{ A}$ , $t_p = 10\text{ ms}$	$\Delta\lambda$	30	nm
Abstrahlwinkel Half angle	$\varphi$	$\pm 60$	Grad deg.
Abmessungen der aktiven Chipfläche <sup>1)</sup> Dimension of the active chip area	$L \times B$ $L \times W$	$2.1 \times 5.4$	mm <sup>2</sup>
Schaltzeiten, $I_e$ von 10% auf 90% und von 90% auf 10%, $I_F = 5\text{ A}$ , $R_L = 50\ \Omega$ Switching times, $I_e$ from 10% to 90% and from 90% to 10%, $I_F = 5\text{ A}$ , $R_L = 50\ \Omega$	$t_r$ , $t_f$	10, 10	ns
Durchlassspannung Forward voltage $I_F = 1\text{ A}$ , $t_p = 100\ \mu\text{s}$	$V_F$	15.5 ( $\leq 19$ )	V
Gesamtstrahlungsfluss Total radiant flux $I_F = 1\text{ A}$ , $t_p = 100\ \mu\text{s}$ SFH 4730 SFH 4740	$\Phi_e$ $\Phi_e$	3.6 4.3	W W
Temperaturkoeffizient von $I_e$ bzw. $\Phi_e$ Temperature coefficient of $I_e$ or $\Phi_e$ $I_F = 1\text{ A}$ , $t_p = 10\text{ ms}$	$TC_I$	- 0.3	%/K
Temperaturkoeffizient von $V_F$ Temperature coefficient of $V_F$ $I_F = 1\text{ A}$ , $t_p = 10\text{ ms}$	$TC_V$	- 10	mV/K
Temperaturkoeffizient von $\lambda$ Temperature coefficient of $\lambda$ $I_F = 1\text{ A}$ , $t_p = 10\text{ ms}$	$TC_{\lambda, \text{centroid}}$	+ 0.3	nm/K

<sup>1)</sup> Die aktive Chipfläche besteht aus 10 einzelnen Chips mit je  $1 \times 1\text{ mm}^2$ .  
The active chip area consists of 10 single chips with  $1 \times 1\text{ mm}^2$  each.

Strahlstärke<sup>1)</sup>  $I_e$   
 Radiant Intensity<sup>1)</sup>  $I_e$

Bezeichnung Parameter	Symbol	Werte Values				Einheit Unit
		SFH 4730 -EB	SFH 4730 -FA	SFH 4740 -FA	SFH 4740 -FB	
Strahlstärke Radiant Intensity $I_F = 1 \text{ A}, t_p = 20 \text{ ms}$	$I_{e \text{ min}}$ $I_{e \text{ max}}$	800 1250	1000 1600	1000 1600	1250 2000	mW/sr mW/sr

<sup>1)</sup> Nur eine Gruppe in einer Verpackungseinheit (Streuung kleiner 1.6:1)  
 Only one group in one packing unit (variation lower 1.6:1)

**Abstrahlcharakteristik**  
**Radiation Characteristics**  $I_{\text{rel}} = f(\varphi)$

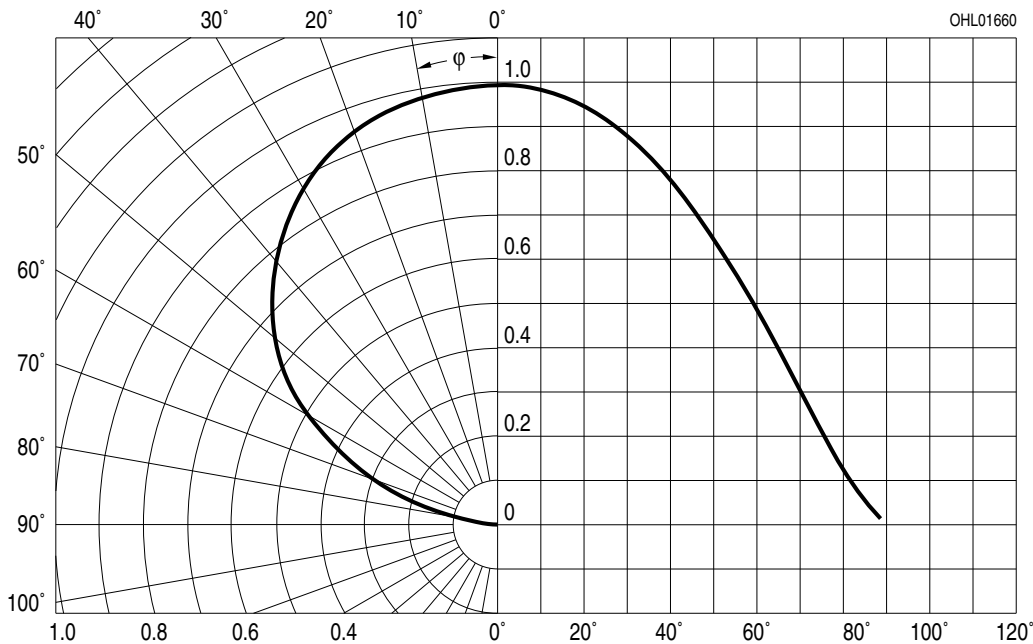

**Relative spektrale Emission**  
**Relative Spectral Emission**

$I_{rel} = f(\lambda), T_B = 25\text{ °C}$

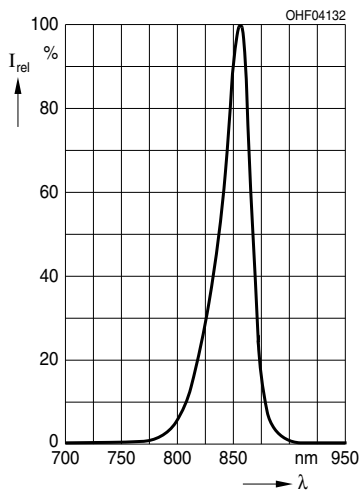

**Durchlassstrom**  
**Forward Current**

$I_F = f(V_F), T_B = 25\text{ °C},$   
Single pulse,  $t_p = 100\text{ }\mu\text{s}$

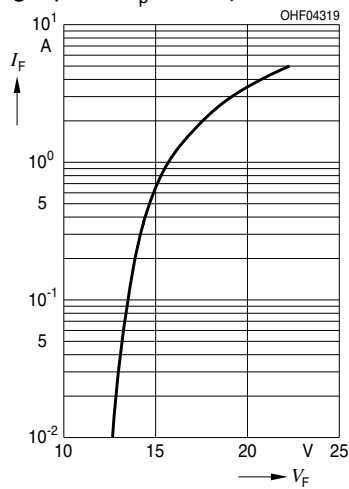

**Relativer Gesamtstrahlungsfluss**  
**Relative Total Radiant Flux**

$\Phi_e / \Phi_e(1A) = f(I_F), T_B = 25\text{ °C},$   
Single pulse,  $t_p = 100\text{ }\mu\text{s}$

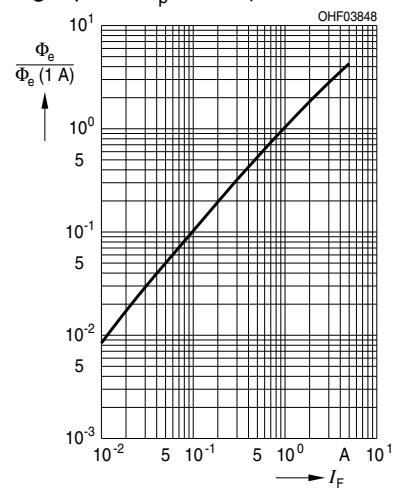

**Max. zulässiger Durchlassstrom**  
**Max. Permissible Forward Current**

$I_F = f(T_B), R_{thJB} = 2.8\text{ K/W}$

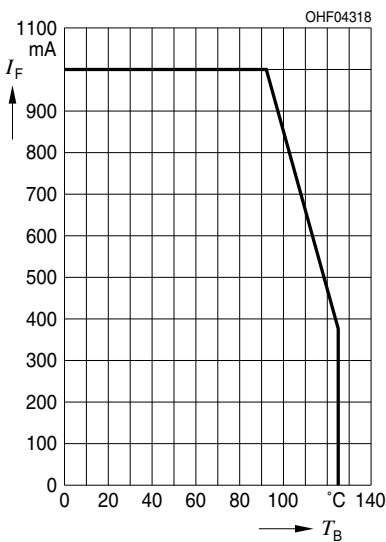

**Zulässige Impulsbelastbarkeit**  
**Permissible Pulse Handling**

**Capability**  $I_F = f(t_p), T_B = 85\text{ °C},$   
Duty cycle  $D = \text{parameter}$

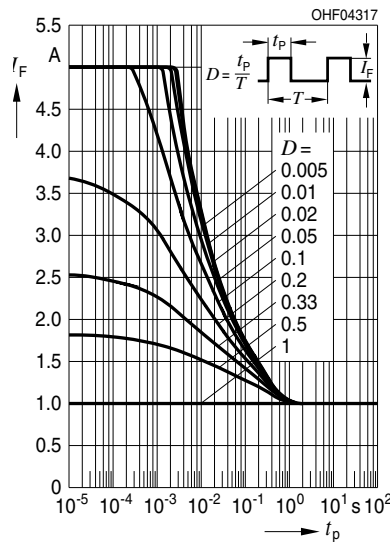

**SMD NTC Thermistor mit Nickel Barrier Termination, Typ 0603**  
**SMD NTC Thermistor with Nickel Barrier Termination, Type 0603**

No. of R/T characteristics	$R_{25}$ [ $\Omega$ ]	$B_{25/50}$ [K]	$B_{25/85}$ [K]	$B_{25/100}$ [K]
EPCOS 8502 / A01	10k $\pm$ 5%	3940	3980	4000

**Typische Thermistor Kennlinie**  
**Typical Thermistor Graph**

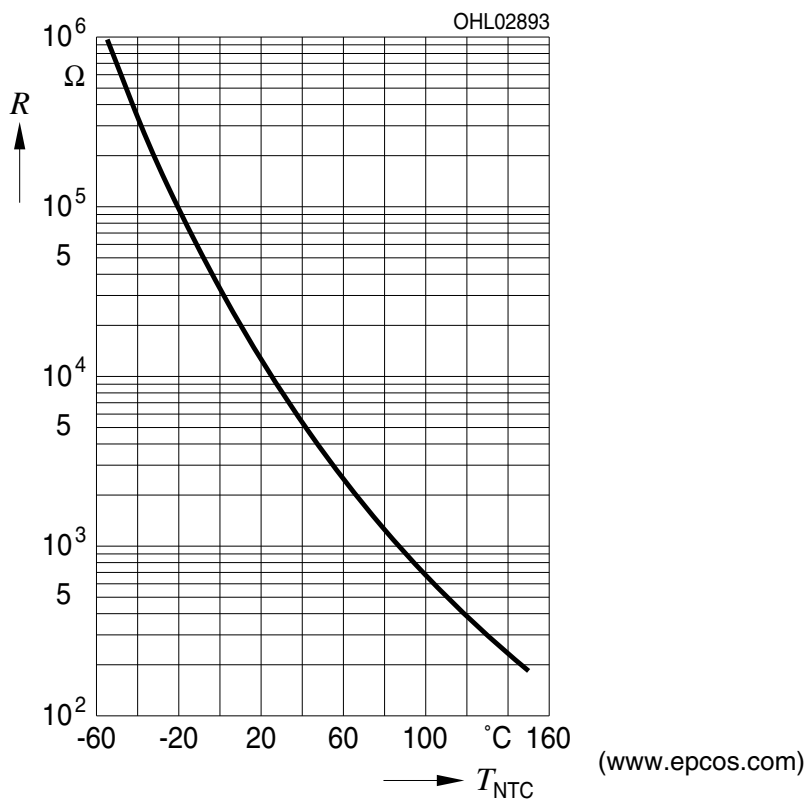

**Maßzeichnung und Ersatzschaltbild**  
**Package Outlines and equivalent circuit diagram**

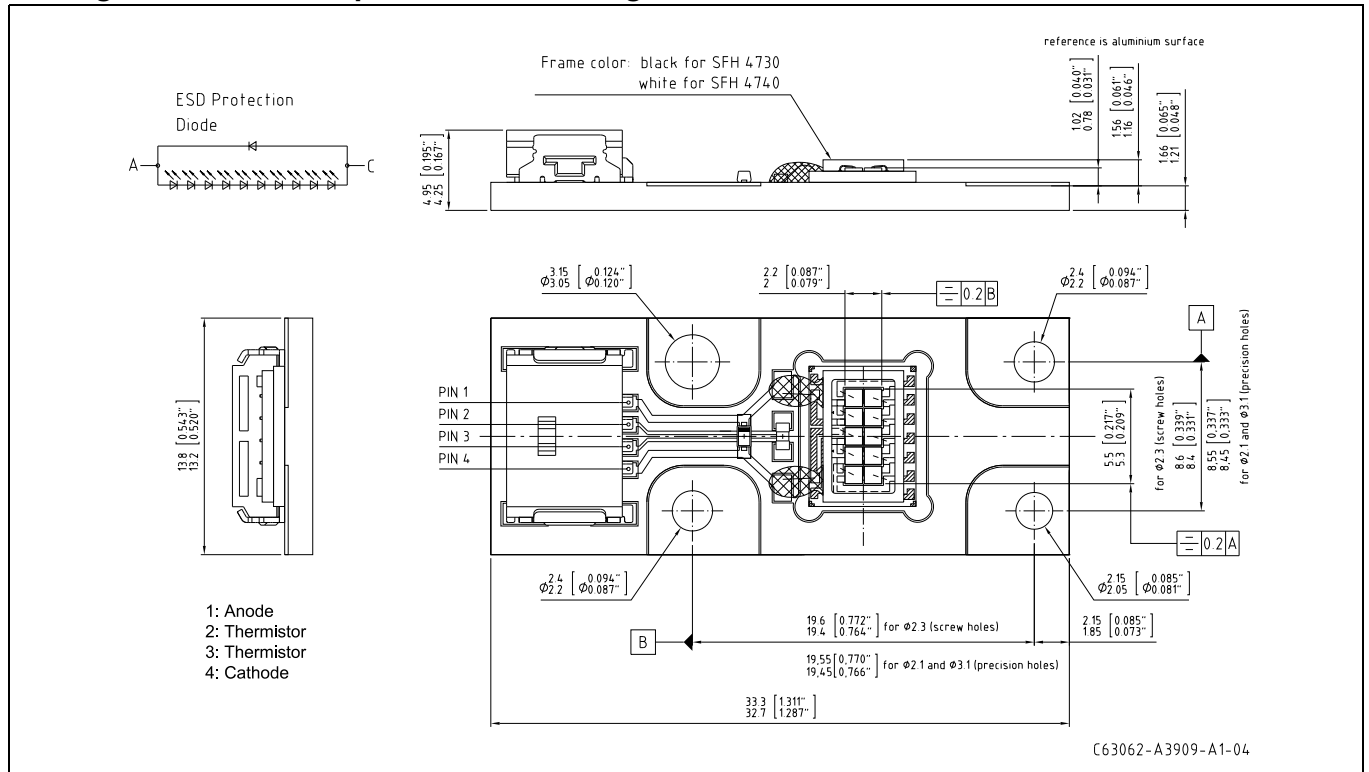

Maße in mm (inch) / Dimensions in mm (inch).

**Verwendeter Stecker / Used male connector on board:**  
 ERNI male connector SMD 214012, 4-pins (www.erni.com)

**Empfohlene Gegenstecker / Recommended female connector for power supply:**  
 ERNI female connector SMD 214025, 4-pins (www.erni.com)

**Published by OSRAM Opto Semiconductors GmbH**  
 Leibnizstraße 4, D-93055 Regensburg  
[www.osram-os.com](http://www.osram-os.com)

EU RoHS and China RoHS compliant product



此产品符合欧盟 RoHS 指令的要求；

按照中国的相关法规和标准，不含有毒有害物质或元素。

**© All Rights Reserved.**

The information describes the type of component and shall not be considered as assured characteristics. Terms of delivery and rights to change design reserved. Due to technical requirements components may contain dangerous substances. For information on the types in question please contact our Sales Organization.

**Packing**

Please use the recycling operators known to you. We can also help you – get in touch with your nearest sales office. By agreement we will take packing material back, if it is sorted. You must bear the costs of transport. For packing material that is returned to us unsorted or which we are not obliged to accept, we shall have to invoice you for any costs incurred.

**Components used in life-support devices or systems must be expressly authorized for such purpose!** Critical components <sup>1</sup>, may only be used in life-support devices or systems <sup>2</sup> with the express written approval of OSRAM OS.

<sup>1</sup> A critical component is a component used in a life-support device or system whose failure can reasonably be expected to cause the failure of that life-support device or system, or to affect its safety or effectiveness of that device or system.

<sup>2</sup> Life support devices or systems are intended (a) to be implanted in the human body, or (b) to support and/or maintain and sustain human life. If they fail, it is reasonable to assume that the health of the user may be endangered.

# Mouser Electronics

## Related Product Links

[720-SFH4730 - Osram Opto Semiconductor SFH 4730](#)

[720-SFH4740 - Osram Opto Semiconductor SFH 4740](#)